

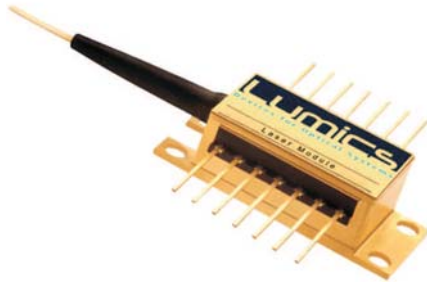

LU1055M200 1055nm Laser Module, Seed Laser c.w. or pulsed mode



Description:

The Lumics LU1055M200 laser diode module contains an optimized GaAs substrate based quantum well high power laser diode. It has been designed for customer specific applications and is available with special FBG's and fibers. The extremely stringent reliability requirements are achieved through our patent pending innovative technology. This includes careful design, exactly defined manufacturing and extensive testing. The qualification contains a set of optoelectronic, thermal and mechanical tests. Each laser diode module is individually serialized for traceability and is shipped with a specified set of test data.

Features & Functions:

- Wavelength 1055nm
- Up to 200mW c.w. operating power
- Up to 1W peak power
- short pulses 5nsec - 500nsec
- single mode pigtail
- cooled 14pin package
- FBG-options
- PM-fiber option

Benefits:

- all Laser welded
- high reliability
- field proven reliability

Applications:

- seeder for fiber laser
- sensor applications

Module Drawing (dimensions in mm)

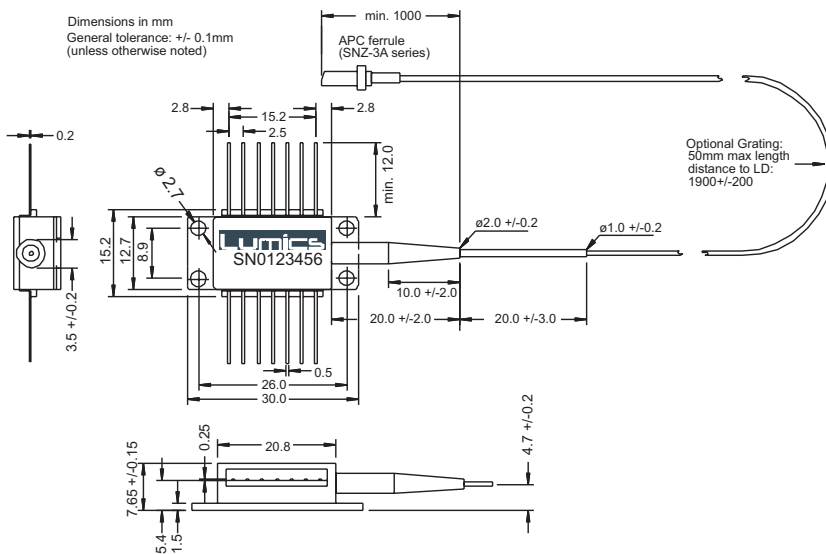

Pin Connections

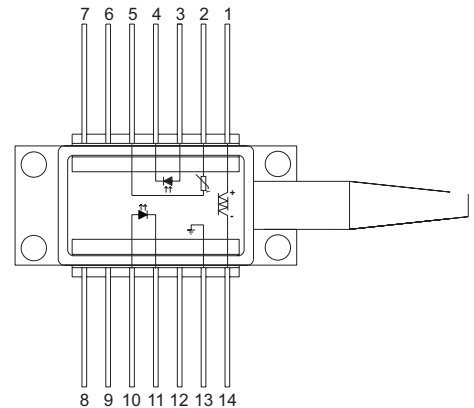

Pin	Function	Pin	Function
1	Cooler (+)	8	nc
2	Thermistor	9	nc
3	PD Anode (+)	10	LD Anode (+)
4	PD Cathode (-)	11	LD Cathode (-)
5	Thermistor	12	nc
6	nc	13	Case ground
7	nc	14	Cooler (-)

Your ideas are welcome.

